

### Features

- APD with 0.2 mm<sup>2</sup> active area
- Slow multiplication curve
- QE > 80% @ 750 nm-910 nm
- Fast rise time, low noise
- Optimum gain: 50-60

### Description

Circular active area APD chip with NIR enhanced sensitivity. Metal can type hermetic TO52 package with 905nm BP filter.

### Application

- Laser range finder
- High speed photometry
- High speed optical communications
- Medical equipment

### RoHS

2011/65/EU

### Absolute maximum ratings

Symbol	Parameter	Min	Max	Unit
T <sub>STG</sub>	Storage temp	-55	125	°C
T <sub>OP</sub>	Operating temp	-40	100	°C
M <sub>max</sub>	Gain (I <sub>PO</sub> = 1 nA)	200		
I <sub>PEAK</sub>	Peak DC current		0.25	mA

### Schematic

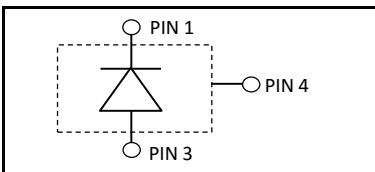

### Spectral response (M = 100)

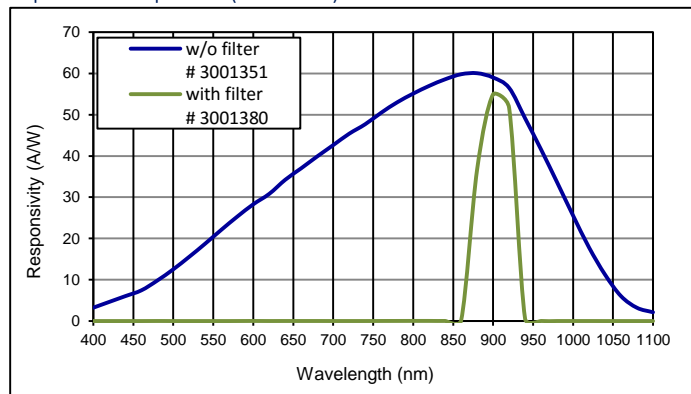

### Electro-optical characteristics @ 23 °C

Symbol	Characteristic	Test Condition	Min	Typ	Max	Unit
	Active area		diameter 500			µm
	Active area		0.196			mm <sup>2</sup>
I <sub>D</sub>	Dark current	M = 100		0.8	2.0	nA
C	Capacitance	M = 100		1.2		pF
	Responsivity with filter	M = 100; λ = 905 nm	38	49		A/W
t <sub>R</sub>	Rise time	M = 100; λ = 905 nm; R <sub>L</sub> = 50 Ω		0.55		ns
	Cut-off frequency	-3dB		0.5		GHz
V <sub>BR</sub>	Breakdown voltage	I <sub>R</sub> = 2 µA	160		200	V
	Temperature coefficient	Change of V <sub>BR</sub> with temperature	1.25		1.55	V/K
	Excess noise factor	M = 100		2.5		
	Excess noise index	M = 100		0.2		

Quantum efficiency (23 °C)

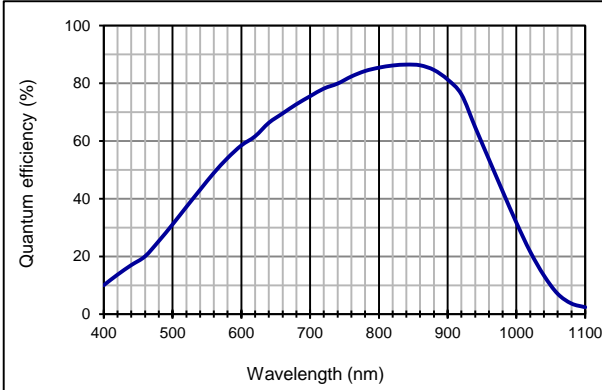

Capacitance as fct of reverse bias (23 °C)

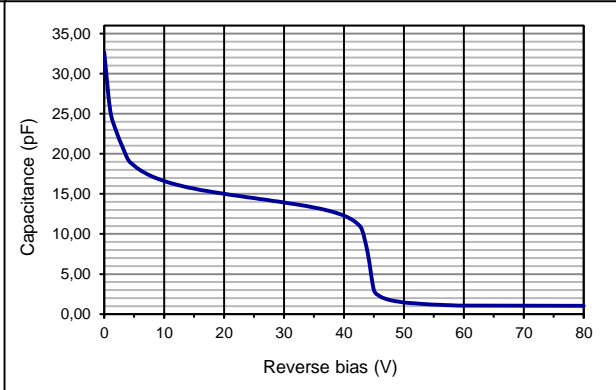

Multiplication as fct of bias (23 °C)

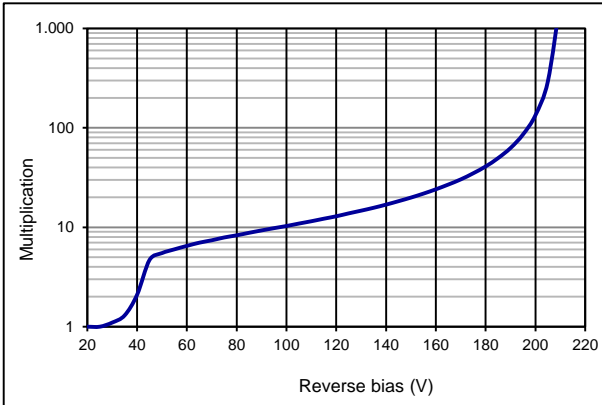

Dark current as fct of bias (23 °C)

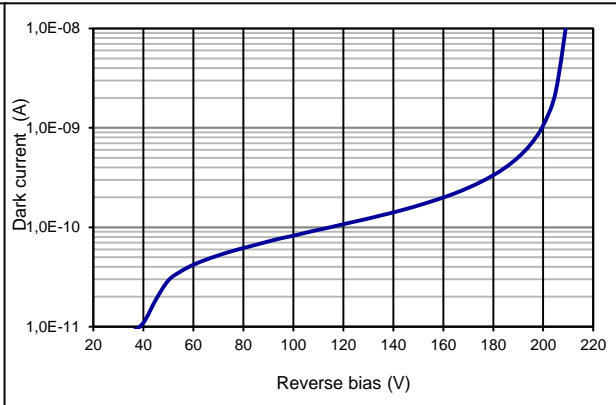

Filter characteristics 905 nm band pass

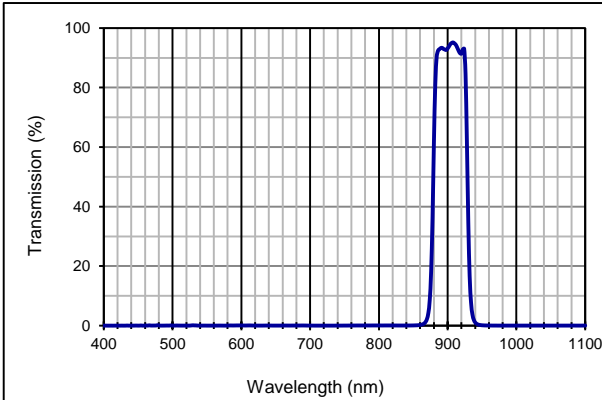

TC as fact of Gain

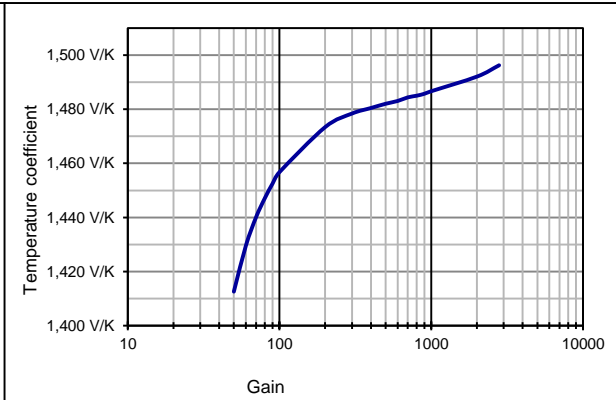

**Application hints:**

- Current should be limited by a protecting resistor or current limiting - IC inside the power supply
- For low light level applications blocking of ambient light should be used
- For high gain applications bias voltage should be temperature compensated
- Please consider basic ESD protection while handling
- Use low noise read-out - IC
- For further questions please refer to document "Instructions for handling and processing"

Package: TO52S1F2

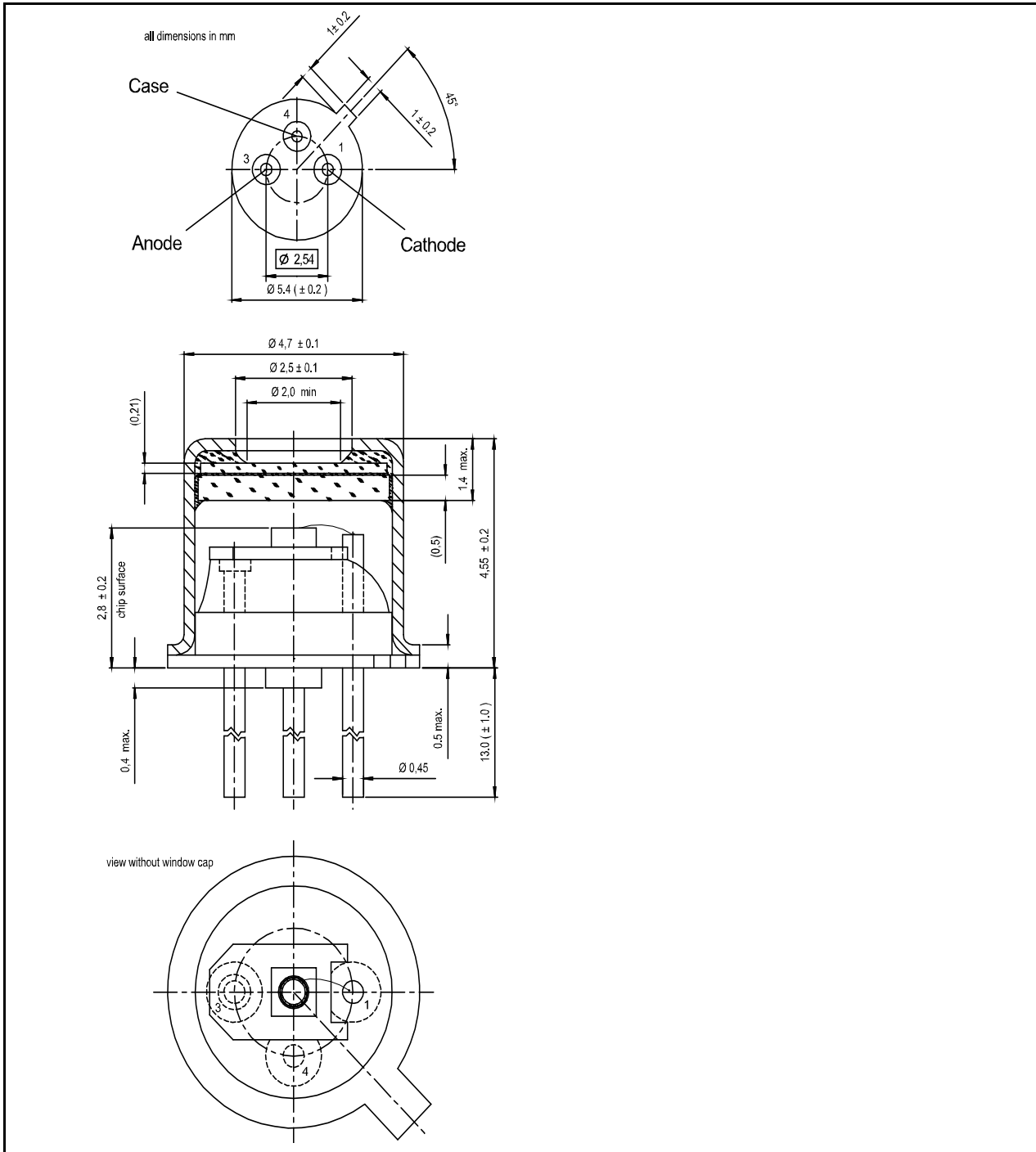

### Package dimension:

Small quantities: Foam pad, boxed (12 cm x 16.5 cm)

Disclaimer: Due to our strive for continuous improvement, specifications are subject to change within our PCN policy according to JESD46C.

# Mouser Electronics

Authorized Distributor

Click to View Pricing, Inventory, Delivery & Lifecycle Information:

[TE Connectivity:](#)

[3001380](#)