

LOC	DIST	REVISIONS					
E	B	P	LTR	DESCRIPTION	DATE	DWN	APVD
			BA	NEW RELEASE	27-Sep-08	SM	St.P

FOR FURTHER INFORMATION SEE DATA SHEET FOR  
CPF SERIES-THIN FILM PRECISION CHIP RESISTORS

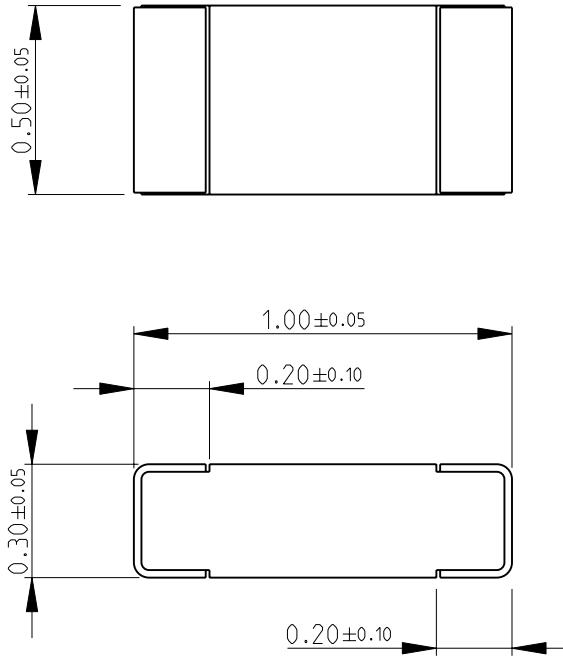

RoHS Compliant

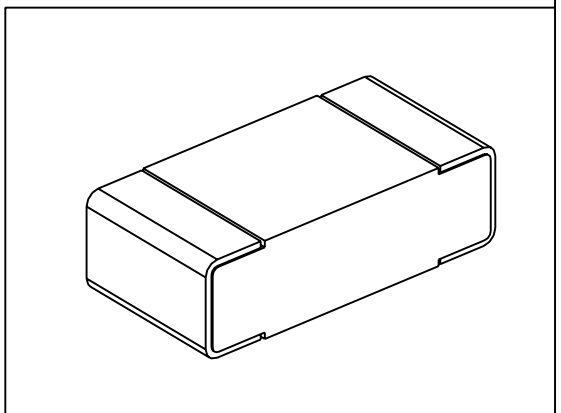

2008

RELEASED FOR PUBLICATION

THIS DRAWING IS UNPUBLISHED.

BY TYCO ELECTRONICS CORPORATION. ALL RIGHTS RESERVED.



DIMENSIONS: mm	DWN	27-Sep-08	MATERIAL	-	FINISH	-
	CHK	27-Sep-08	Tyco Electronics Corporation Dorcan, Swindon, SN3 5HH			
TOLERANCES UNLESS OTHERWISE SPECIFIED:	APVD	27-Sep-08				
0 PLC $\pm 0.2$	PRODUCT SPEC	-	NAME THIN FILM PRECISION CHIP RESISTORS SERIES CPF 0402			
1 PLC $\pm 0.1$	APPLICATION SPEC	-				
2 PLC $\pm$	WEIGHT	-	SIZE	A 4	CAGE CODE	00779
3 PLC $\pm$			DRAWING NO	C= 1879216		RESTRICTED TO
4 PLC $\pm$						-
ANGLES $\pm 5^\circ$						
	CUSTOMER DRAWING		SCALE	50:1	SHEET	1 OF 1
						REV BA

# Mouser Electronics

Authorized Distributor

Click to View Pricing, Inventory, Delivery & Lifecycle Information:

[TE Connectivity:](#)

[CPF0402B69K8E1](#)